

TDK | 东京电子 RSHN-2006 PDF



深圳创唯电子有限公司

<http://www.tdk-dz.com>

深圳市创唯电子有限公司

电话：400-900-3095 0755-21000796

手机：13006692189

企业QQ：800152669

公司官网：<http://www.szcwdz.com>

3A to 300A, 250VAC EMI Filters

Features

- ◆ Two Stage Filter for Better Performance
- ◆ DIN Rail Mount Option (Up 30A)
- ◆ Low Earth Leakage Current Option (Up to 30A)
- ◆ Conforms to UL, CSA and EN Safety Agency Certifications



Key Market Segments & Applications



Specifications						
Model		RSHN-2003 RSHN-2003D RSHN-2003L	RSHN-2006 RSHN-2006D RSHN-2006L	RSHN-2010 RSHN-2010D RSHN-2010L	RSHN-2016 RSHN-2016D RSHN-2016L	RSHN-2020 RSHN-2020D RSHN-2020L
Rated Voltage (AC, DC)	V	250V				
Rated Current	A	3A	6A	10A	16A	20A
DC Resistance (total)	mΩ	350	140	60	35	22
Model		RSHN-2030 RSHN-2030D RSHN-2030L	RSHN-2040	RSHN-2050	RSHN-2060	RSHN-2080
Rated Voltage (AC, DC)	V	250V				
Rated Current	A	30A	40A	50A	60A	80A
DC Resistance (total)	mΩ	12	10	8	6	7
Model		RSHN-2100	RSHN-2150	RSHN-2200	RSHN-2250	RSHN-2300
Rated Voltage (AC, DC)	V	250V				
Rated Current	A	100A	150A	200A	250A	300A
DC Resistance (total)	mΩ	6	4	3	2	1.5
Withstand Voltage	V	Terminals to Case: 2500VAC (1 Minute)				
Isolation Resistance	MΩ	100MΩ minimum (500VDC, 1 Minute)				
Leakage Current (max)	A	RSHN-20xx 1mA; RSHN20xxL 100uA (250VAC, 60Hz)				
Operating Temperature	°C	-25 to +85°C (Derate above 50 / 55°C, see derating curve)				
Storage Temperature	°C	-25 to +85°C				
Safety Agency Certifications	-	Up to 30A Models - UL1283, CSA C22.2 No.8, EN60939				
Weight	g	190g to 13000g model dependant (See weights chart on website)				
Warranty	yr	1 Year				

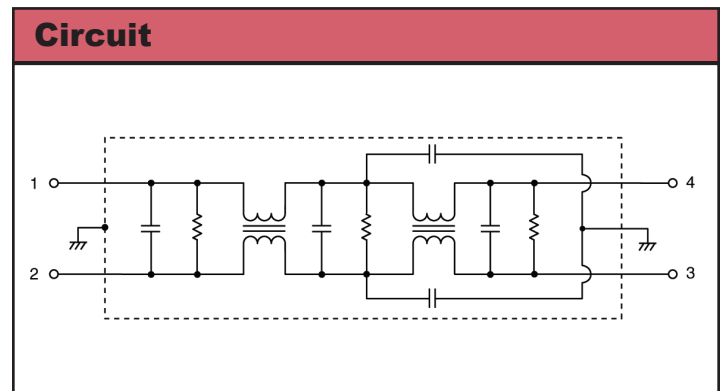
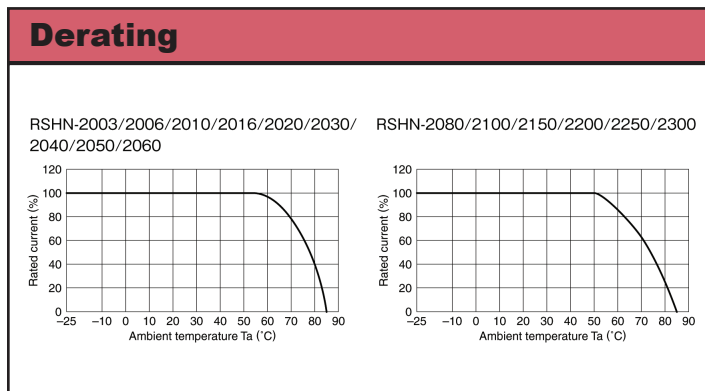

Options

Chassis Mount & Standard Leakage Current	RSHN-20xx
DIN Rail Mount & Standard Leakage Current	RSHN-20xxD
Chassis Mount & Low Leakage Current	RSHN-20xxL

Outline Drawing

RSHN-2003/2006/2010/2016/2020/2030

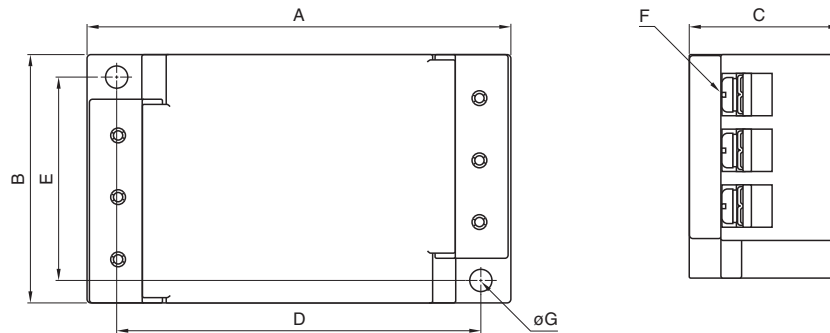

RSHN-2040/2050/2060/2080/2100/2150/2200/2250/2300

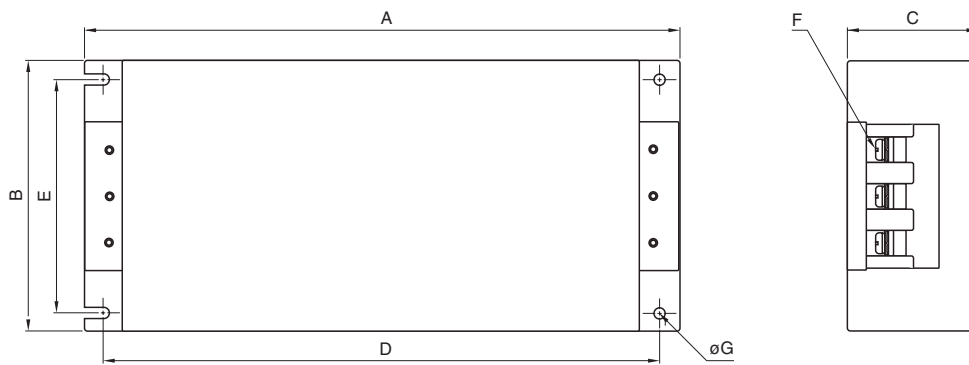

Dimensions in mm

Part No.	A	B	C	D	E	F	G	Recommended clamping torque
RSHN-2003	98	52	35	86	43	M4	4.5	1.27N m
RSHN-2006								
RSHN-2010								
RSHN-2016	127	52	35	115	43	M4	4.5	1.27N m
RSHN-2020								
RSHN-2030								
RSHN-2040	272	100	60	254	82	M5	5.5	2.5N m
RSHN-2050								
RSHN-2060								
RSHN-2080	430	161	85	410	135	M8	6.5	7.64N m
RSHN-2100								
RSHN-2150								
RSHN-2200	593	195	103	573	169	M10	6.5	11.8N m
RSHN-2250								
RSHN-2300								

For Additional Information, please visit
us.tdk-lambda.com/lp/products/r-series.htm

